

# Specification

**Model No: AL-YL503C1W**

## Descriptions

- 5mm Round With Flange Type
- Round Color: Yellow
- Viewing Angle: 25°

## **NINGBO ANDY OPTOELECTRONIC CO., LTD**

Add: Xinan Street Industrial Zone, Yuyao City, Zhejiang, China  
Tel: +86-0574-62593879 62593880 Fax: +86-0574-62593850  
Http://www.ledlighting.cc E-mail:sales@ledlighting.cc

**Package Dimension:**

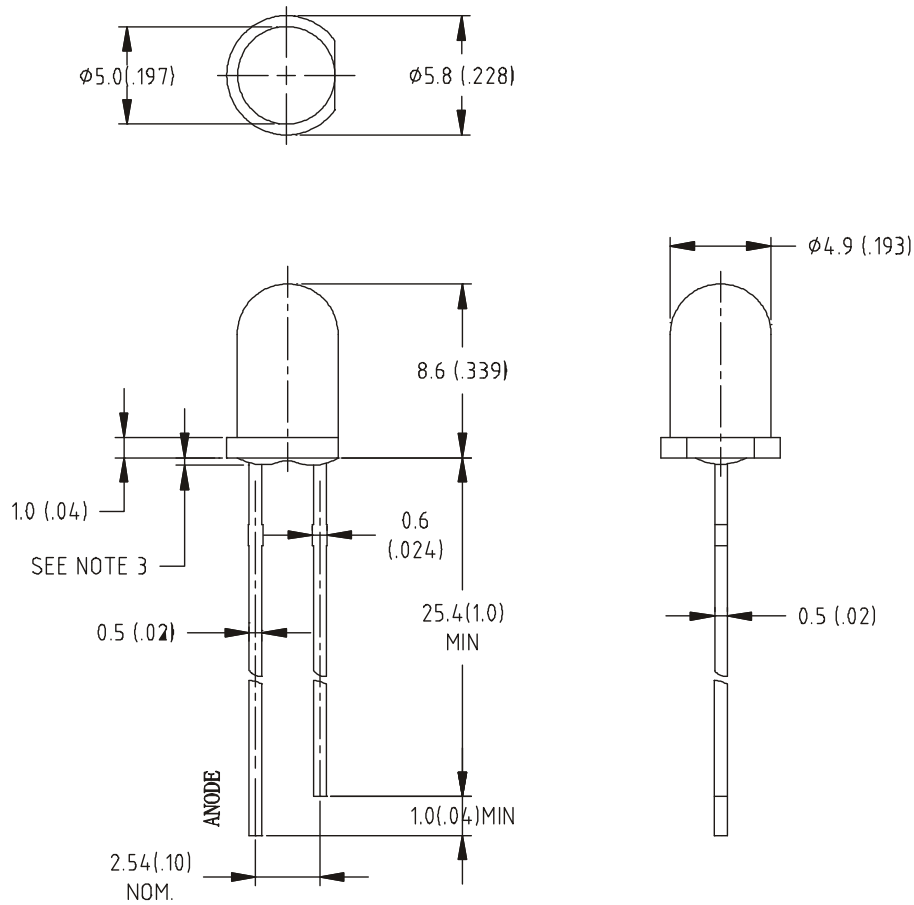

Part No.	Material	Lens Color	Source Color
AL-YL503C1W	AlGaInP	Water Clear	Yellow

**Notes:**

1. All dimensions are in millimeters (inches).
2. Tolerance is  $\pm 0.25 (.010)$  mm unless otherwise noted.
3. Protruded resin under flange is 1.0mm(.04") max
4. Specifications are subject to change without notice.

**Absolute Maximum Ratings at Ta=25°C**

Parameter	Symbol	MAX	Unit
Power Dissipation	P <sub>D</sub>	80	mW
Peak Forward Current (1/10 Duty Cycle, 0.1ms Pulse Width)	I <sub>FP</sub>	100	mA
Continuous Forward Current	I <sub>F</sub>	30	mA
Reverse Voltage	V <sub>R</sub>	5	V
Operating Temperature Range	T <sub>opr</sub>	-30°C to +85°C	
Storage Temperature Range	T <sub>stg</sub>	-40°C to +100°C	
Lead Soldering Temperature [4mm(.157") From Body]	T <sub>sld</sub>	260°C for 5 Seconds	

**Electrical Optical Characteristics at Ta=25°C**

Parameter	Symbol	Min.	Type.	Max.	Unit	Test Condition	
Viewing Angle	2θ <sub>1/2</sub>	---	25	---	Deg	(Note 2) *	
Forward Voltage	V <sub>F</sub>	1.8	2.1	2.4	V	I <sub>F</sub> =20mA	
Reverse Current	I <sub>R</sub>	---	---	10	μA	V <sub>R</sub> =5V	
Peak Emission Wavelength	λ <sub>p</sub>	---	---	595	nm	I <sub>F</sub> =20mA	
Dominant Wavelength	λ <sub>d</sub>	585	590	595	nm		
Luminous Intensity (Note 1) *	3BC	IV	2000	3000	4000	mcd	I <sub>F</sub> =20mA
	3DC	IV	4000	6000	8000	mcd	I <sub>F</sub> =20mA
	3EC	IV	2000	3000	4000	mcd	I <sub>F</sub> =20mA

- Luminous Intensity Measurement allowance is±10%
- θ<sub>1/2</sub> is the off-axis angle at which the luminous intensity is half the axial luminous intensity

Reliability

1) Test Items and Results

Test Item	Standard Test Method	Test Conditions	Note	Number of Damaged
Resistance to Soldering Heat	JEITA ED-4701 300 302	Tsld=260±5℃,10sec 3mm from the base of the epoxy bulb	1 time	0/100
Solder ability	JEITA ED-4701 300 303	Tsld=235±5℃,5sec(using flux)	1time over 95%	0/100
Thermal Shock	JEITA ED-4701 300 307	0℃~100℃ 15sec,15sec	100 cycles	0/100
Temperature Cycle	JEITA ED-4701 100 105	-40℃~25℃~100℃~25℃ 30min,5min,30min,5min	100 cycles	0/100
Moisture Resistance Cyclic	JEITA ED-4701 200 203	25℃~65℃~-10℃ 90%RH 24hrs/1cycle	10 cycles	0/100
High Temperature Storage	JEITA ED-4701 200 201	Ta=100℃	1000hrs	0/100
Terminal Strength (Pull test)	JEITA ED-4701 400 401	Load 10N (1kgf) 10±1sec	None damage	0/100
Terminal Strength (bending test)	JEITA ED-4701 400 401	Load 5N (0.5kgf) 0°~90°~0° bend 2 times	None damage	0/100
Temperature Humidity Storage	JEITA ED-4701 100 103	Ta=60℃,RH=90%	1000hrs	0/100
Low Temperature Storage	JEITA ED-4701 200 202	Ta=-40℃	1000hrs	0/100
Steady State Operating Life		Ta=25℃, If=30mA	1000hrs	0/100
Steady State Operating Life of High Humidity Heat		Ta=60℃, RH=90% ,If=30mA	500hrs	0/100
Steady State Operating Life of Low Temperature		Ta=-30℃, If=20mA	1000hrs	0/100

2) Criteria for Judging the Damage

Item	Symbol	Test Conditions	Criteria for Judgment	
			Min	Max
Forward Voltage	VF	If=20mA	—	F.V.*)×1.1
Reverse Current	IR	VR=5V	—	F.V.*)×2.0
Luminous Intensity	IV	If=20mA	F.V.*)×0.7	—

\*) F.V.: First Value

## Typical Electrical / Optical Characteristics Curves

(25°C Ambient Temperature Unless Otherwise Noted)

**Spectrum Distribution Ta=25°**

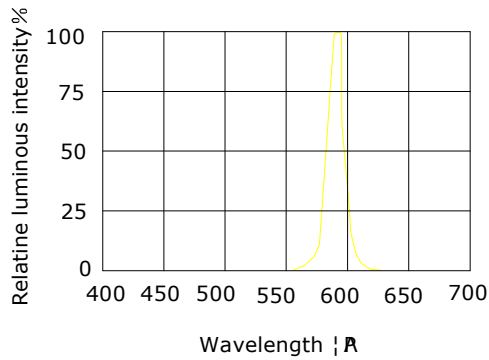

**Forward Voltage vs. Forward Current (Ta=25°C)**

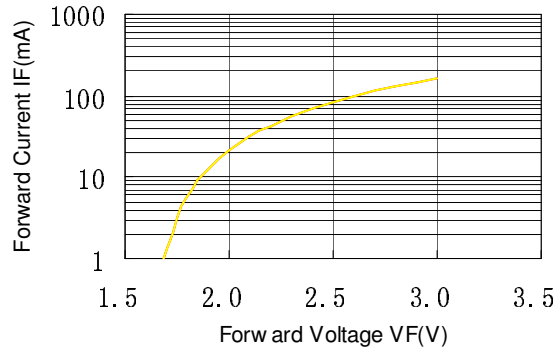

**Relative Luminous Intensity vs. Forward Current**

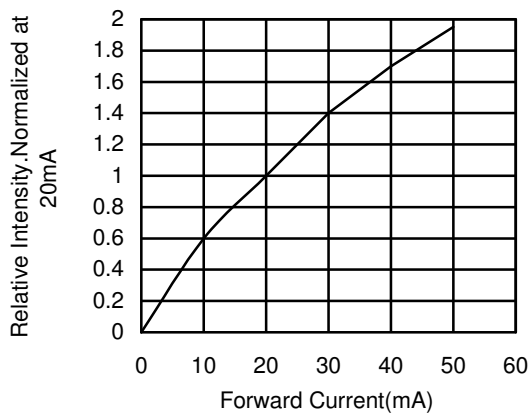

**Relative Luminous Intensity vs. Ambient Temperature (IF=20mA)**

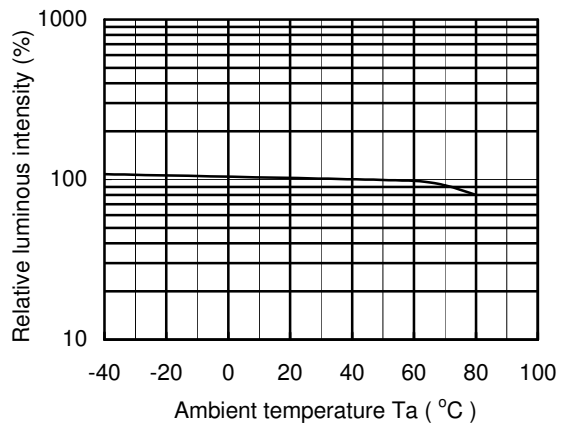

**Forward Current Derating Curve Ta=25°**

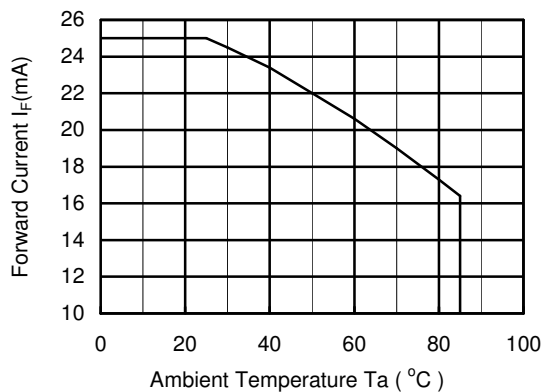

**Beam Pattern**

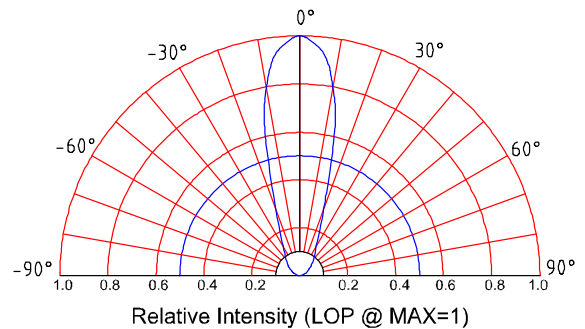

## CAUTIONS

### 1 Lead Forming

- 1) Any forming on the lead must be done before soldering, not during or after soldering.
- 2) Avoid applying any stress to resin for preventing the epoxy fracture and break up bonding wire.
- 3) While forming, please use a tie bar cut or equivalent to hold or bend the pin
- 4) 2 mm from the base or resin is the minimum of distance for the bending point at the lead pin
- 5) Avoid bending the lead pin at the same point twice or more.

### 2 Cleaning

- 1) It is recommended that isopropyl alcohol be used as a solvent for cleaning the LEDs. When using other solvents, it should be confirmed beforehand whether the solvents would dissolve the resin or not.
- 2) Do not clean the LEDs with the ultrasonic. When it is absolutely necessary, the influence of ultrasonic cleaning on the LEDs depends on factors such as ultrasonic power and the assembled condition. Before cleaning, a pre-test should be done to confirm whether any damage to the LEDs would occur.

### 3 Soldering

- 1) The whole pitch on PCB must match lead pin pitch so as not to cause any stress on lead wires.
- 2) No heat should be applied to lead pins when they are soldered, otherwise disconnection may occur.
- 3) Three minutes are necessary for LED to cool down to room temperature.

### 4 Static Electricity

- 1) Static electricity or surge voltage damages the LEDs. It is recommended that a wrist band or an anti-electrostatic glove be used when handling the LEDs.
- 2) All devices, equipment and machinery must be properly grounded. It is recommended that measures be taken against surge voltage to the equipment that mounts the LEDs.
- 3) When inspecting the final products in which LEDs were assembled, it is recommended to check whether the assembled LEDs are damaged by static electricity or not. It is easy to find static-damaged LEDs by a light-on test or a VF test at a lower current (below 1mA is recommended).
- 4) Damaged LEDs will show some unusual characteristics such as the leak current remarkably increases, the forward voltage becomes lowers, or the LEDs do not light at the low current.
- 5) Criteria ( $V_F > 2.0v$  at  $I_F = 0.5mA$ )

### 5 Heat Generation

- 1) Thermal design of the end product is very importance. Please consider the heat generation of the LED when making the system design .The coefficient of temperature increase per input electric power is affected by the thermal resistance of the PCB board and the placement of the LEDs, as well as other components. It is necessary to avoid intense heat generation and operate within the maximum ratings given in this specification.
- 2) The operating current should be decided after considering the ambient maximum temperature of LEDs.

## **6 Storage**

- 1) The LEDs should be stored at 30°C or less and 70%RH or less after being shipped from Andy and the storage life limits are 3 months. If the LEDs are stored for 3months or more, they can be stored for a year in a sealed container with a nitrogen atmosphere and moisture absorbent material.
- 2) Soldering should be done after opening the package (within 24Hrs). If the package has been opened more than 1 week or the color of desiccant changes, LEDs should be dried for 10-12hr at 60±5°C.
- 3) Generally, the lead frames of the LED are comprised of silver and copper. The silver surface may be affected by the environments which contain the corrosive gases and so on. Please avoid conditions that may cause the LED to corrode, tarnish or discolor. This corrosion or discoloration may cause difficult soldering operations. It is recommended that the LEDs be used as soon as possible.
- 4) Please avoid rapid transitions in ambient temperature, especially, in high humidity environments where condensation can occur.

## **7 Others**

- 1) Care must be taken to ensure that the reverse voltage will not exceed the absolute maximum rating when using the LEDs with matrix drive.
- 2) Flashing lights have been known to cause discomfort in people; you can prevent this by taking precautions during use. Also, people should be cautious when using equipment that has had LEDs incorporated into it.
- 3) The LEDs described in this brochure are intended to use for ordinary lighting applications (such as decoration, assistant lighting, backlight, and display). Consult sales staff in advance for information on the special applications, we will offer the suitable products.
- 4) The appearance and specifications of the product may be modified for improvement without notice.